

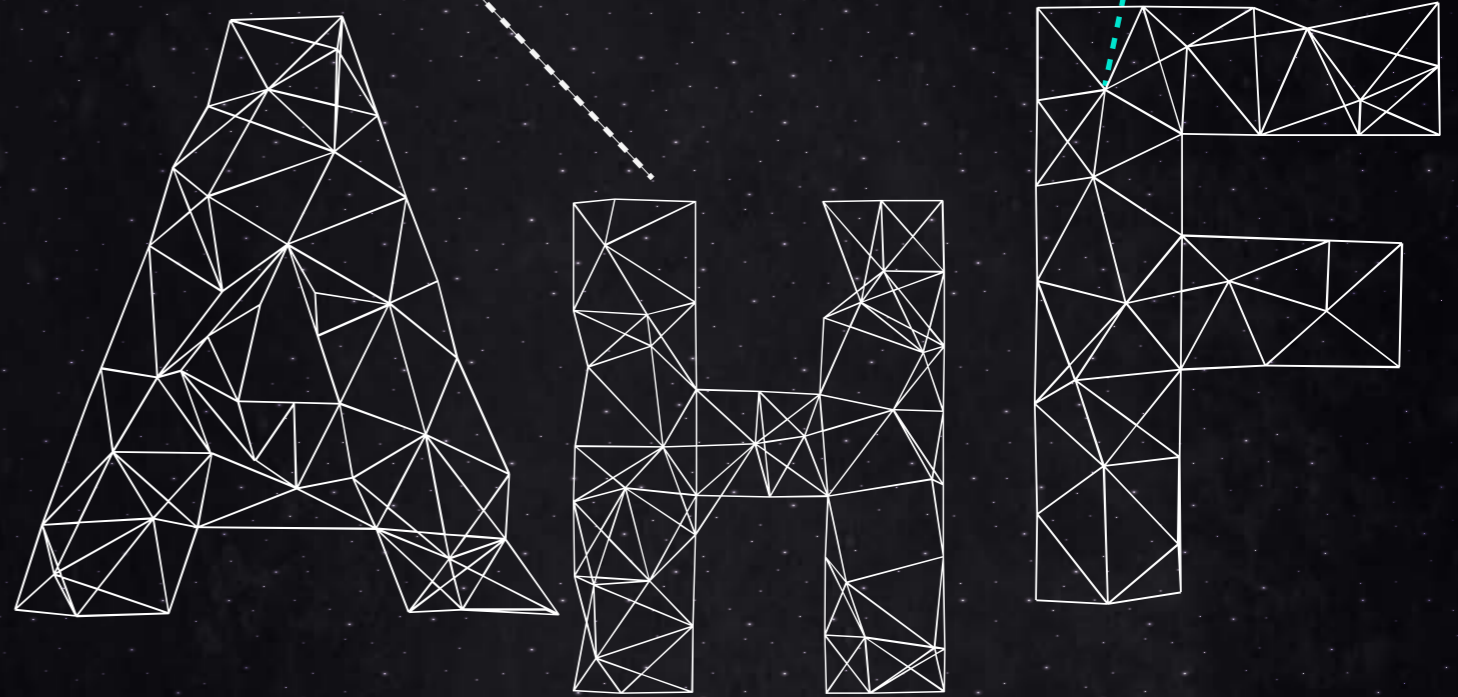

**Sinexcel**

Power Quality

Energy Efficiency



Flexible Alternative Current  
Harmonic Mitigation

Inverter Based PQ  
Active Harmonic Filter

**Modular  
Solution**



Front View

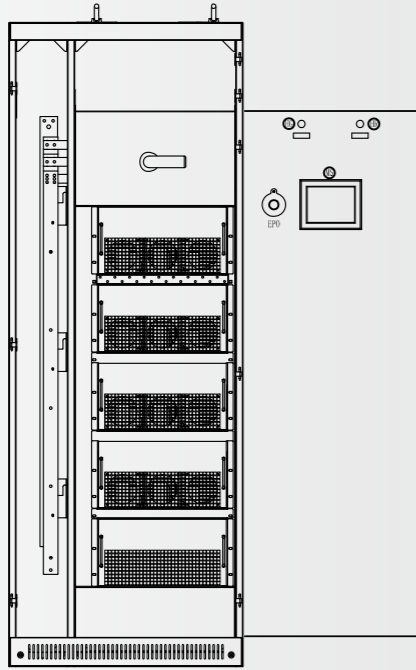

Left Side View

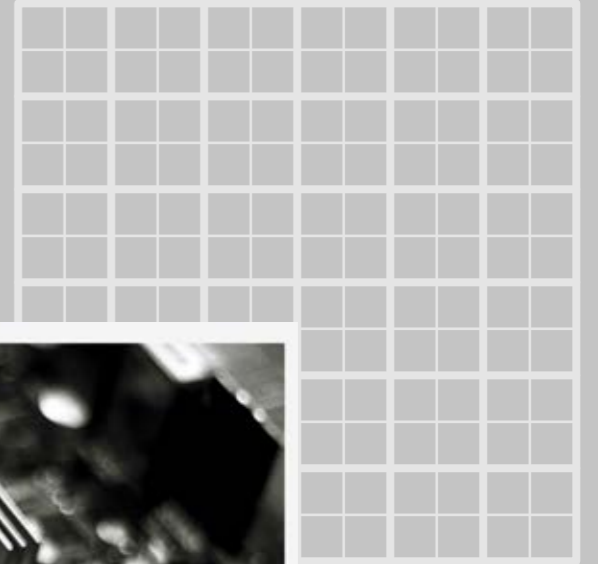
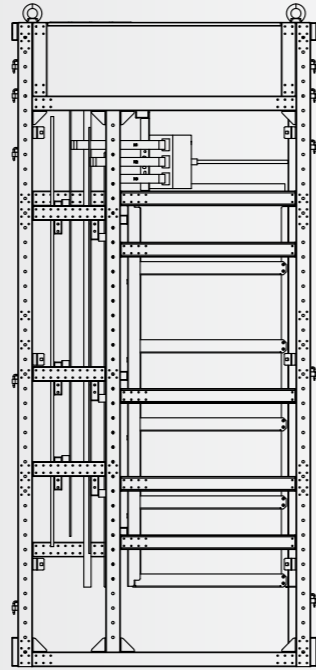

S I N E X C E I

# NONLINEAR LOADS

Different compensation models for different loads



## NONLINEAR LOADS

### INDUSTRIAL EQUIPMENT

Induction furnaces, static converters, VFD, welding machines

### OFFICE EQUIPMENT

Computers, servers, printers

### HOUSEHOLD APPLIANCES

Fluorescent lightings, TV light, dimmers, microwave ovens.

### UNINTERRUPTIBLE POWER SUPPLIES (UPS)

## WHY HARMONIC HURT YOUR SYSTEM?

Higher harmonic current would lead to capacitors' inner swelling, oil spilling and fire risk, severe discharge, flashover and overheat, resulting in over-current and over-voltage, accelerating the aging of the capacitor dielectric, lower safety levels of installations, which cause the unnecessary financial losses.

Higher orders harmonic cause more serious distortion on the grid voltage and current waveform, which will increase the transformer copper and iron losses or load imbalance.

Affect the equipment efficiency and occupy unnecessary grid capacity cause overheating of equipment and shortening the lifetime.

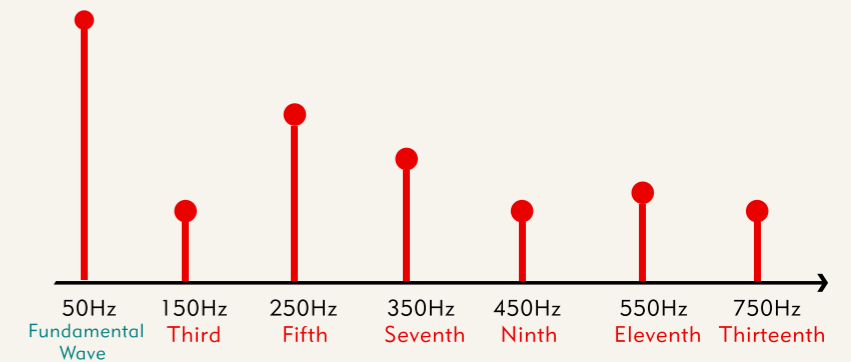

Electrical network with poor power quality results in financial loss and safety concerns. Good power quality not only improves the efficiency of the energy by decreasing the loss of electrical equipment, but also guarantees that the power system could support stable and healthy operation. It becomes more and more convenient for us both in daily life and industry because of fast developing technology, which is also accompanied with the development of non-linear loads.

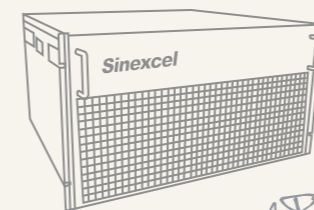

AAI Inverter Base



# AHF WORKING PRINCIPLE

Optimize your harmonic compensation efficiency

- Flexible Alternative Current
- Harmonic Mitigation
- Inverter Based PQ
- Active Harmonic Filter

External CT detect the load current, DSP as CPU has advanced logic control arithmetic, could quickly track the instruction current, divides the load current into active power and reactive power by using the intelligent FFT, and calculates the harmonic content rapidly and accurately. Then sends PWM signal to internal IGBT's driver board to control IGBT on and off at 20KHZ frequency. Finally generates opposite phase compensation current on inverter induction, at the same time CT also detects the output current and negative feedback goes to DSP. Then DSP proceeds the next logical control to achieve more accurate and stable system.

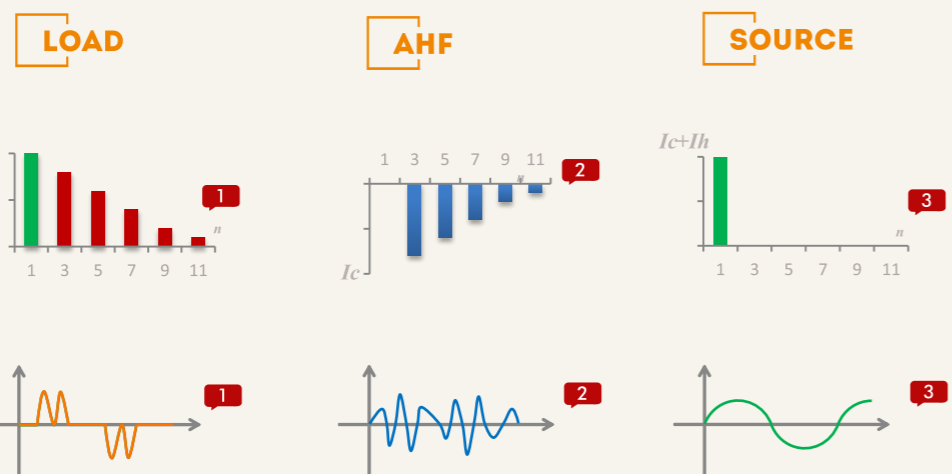
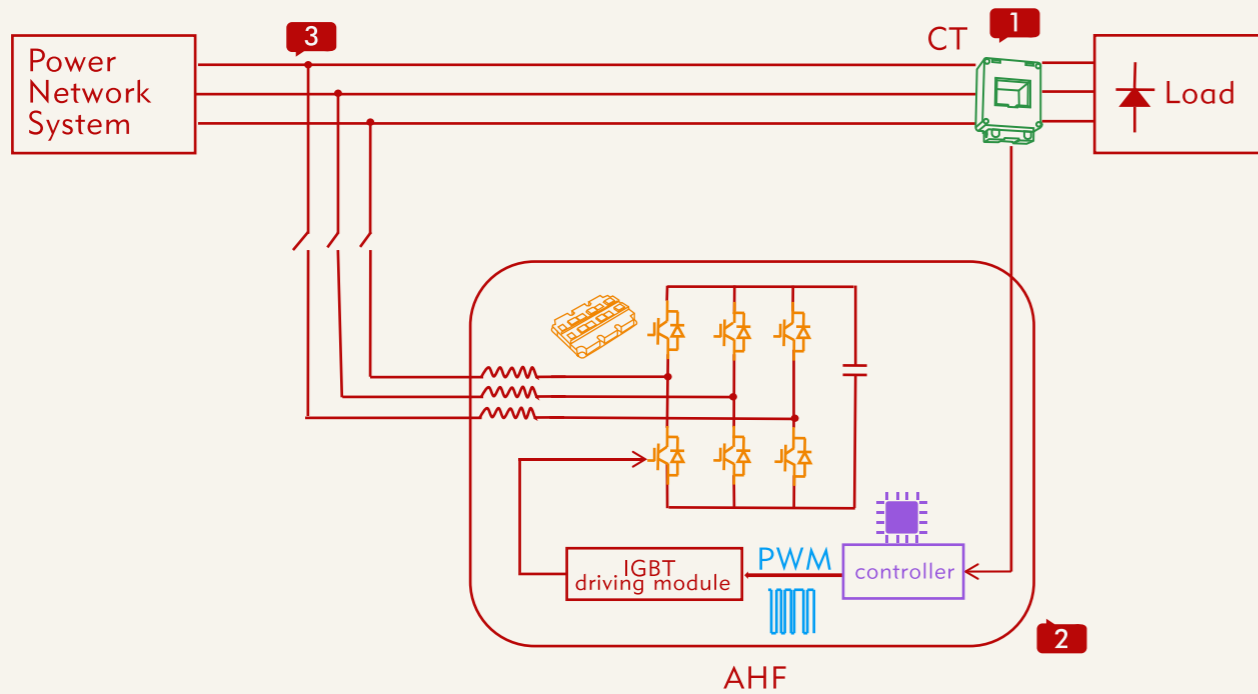

SPECTRUM

WAVEFORM

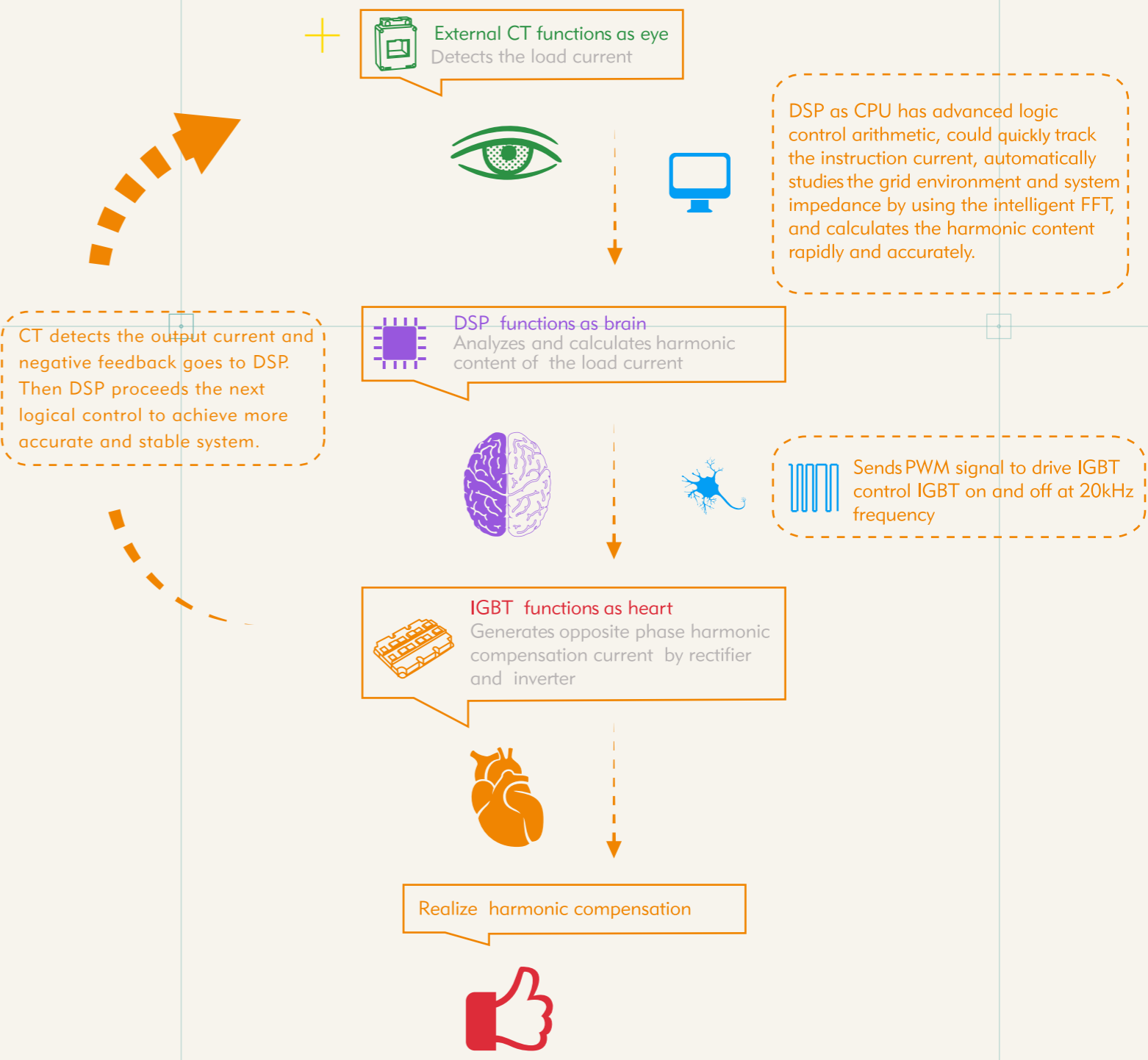

External CT functions as eye  
Detects the load current

DSP as CPU has advanced logic control arithmetic, could quickly track the instruction current, automatically studies the grid environment and system impedance by using the intelligent FFT, and calculates the harmonic content rapidly and accurately.

DSP functions as brain  
Analyzes and calculates harmonic content of the load current

CT detects the output current and negative feedback goes to DSP. Then DSP proceeds the next logical control to achieve more accurate and stable system.

Sends PWM signal to drive IGBT control IGBT on and off at 20kHz frequency

IGBT functions as heart  
Generates opposite phase harmonic compensation current by rectifier and inverter

Realize harmonic compensation





# UNDERSTAND HOW AHF COMPENSATE HARMONIC

Optimize your harmonic compensation efficiency

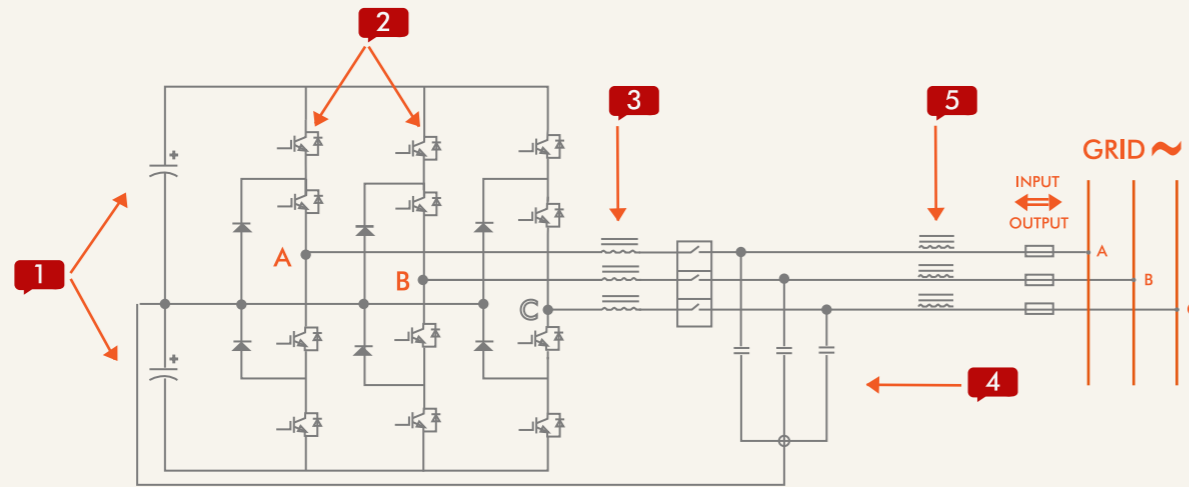

## DC BUS CAPACITOR

AC to DC rectifier storage

## IGBT

Controlled by DSP software algorithm, IGBT on-off timing selection and length could control inverter to generate a harmonic current.

IGBT generates square wave, it's outline is like sinusoid.

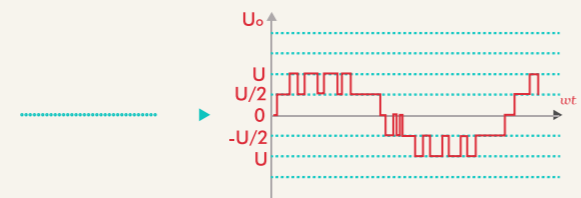

## INVERTER INDUCTION

The square wave will convert into triangular wave, which is more like sinusoid after inverter inductor.

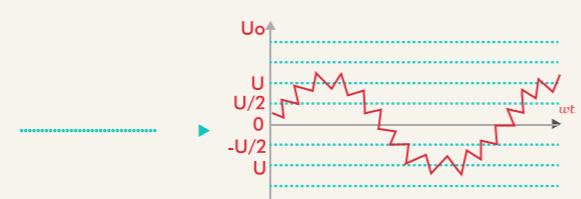

## LCL FILTER CIRCUIT

### LC FILTER CIRCUIT

LC filter circuit filter out impurities of the harmonic. The rest of high frequency harmonic will be filtered by the high frequency inductor.



## HIGH FREQUENCY INDUCTOR

Both for filtering. The combination of LC filter circuit and high frequency inductor are called LCL filter circuit

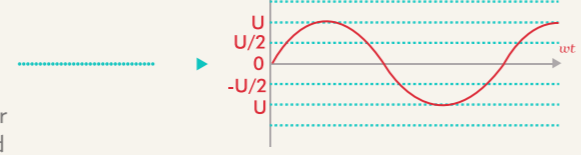

# KEY FEATURES AND BENEFITS

Impressive compensation effect of AHF

## MODULAR DESIGN

Ultra-compact design, wall and rack mount installation, easy to use in new or upgrade exiting switch room

Module structure with highest reliability of system

3P4W and 3P3W adapted by same modules, same harmonic mitigation capability

## INTELLIGENT FFT

Unique intelligent FFT algorithm automatically studies the electrical system impedance, to prevent system from resonance, high system reliability

Real time electrical system resonance monitor and management

## GRAPHICAL USER INTERFACE

Module 4.3 inch HMI, cabinet 7 inch HMI central

Display electrical system voltage, current, frequency, before and after THDi, Apparent/Active/Reactive power, etc

Display before and after waveform, spectrum in same page with clearly comparison

## MAINTENANCE FREE DESIGN

Independent air flow, separates electronic components from air flow. Free of dust cleaning maintenance requirement improves product reliability

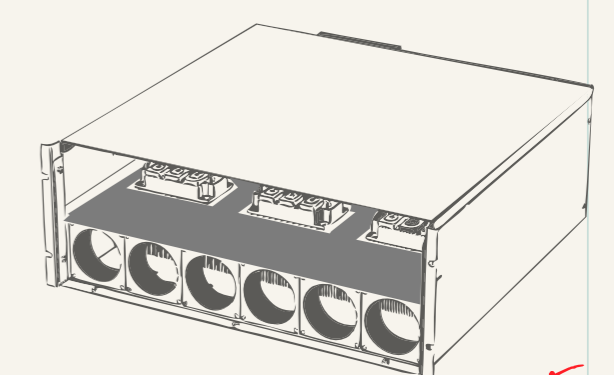
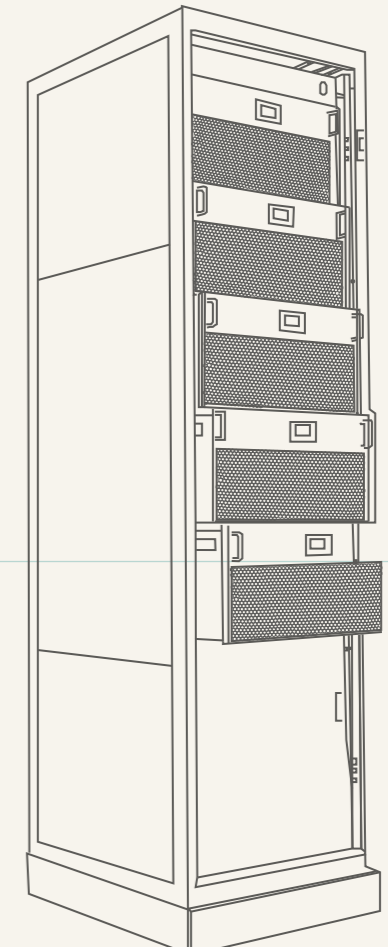

*AHF Cabinet*

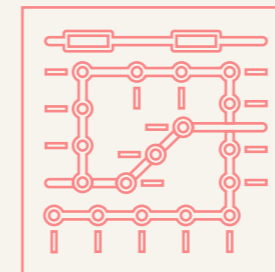

INVERTER



400V Grid Voltage

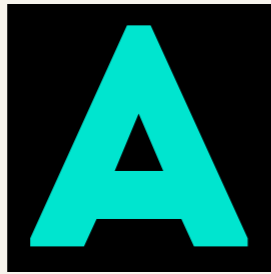
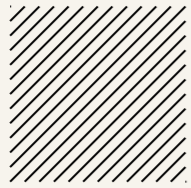

Specification

Items
Input phase voltage range
Power grid frequency
Parallel operation
Overall efficiency
Power grid structure
CT Ratio
Circuit topology
Rated capacity
Function
Control algorithm
Filtering range
Filtering performance
Reaction time
Overall response time
Target power factor
Switch frequency
Cooling air requirement
Noise level
Communications ports
Communications protocols
Module display interface
Protection functions
Monitoring alarm
Fault alarm
Mounting type
Dimensions(W x D x H)mm
Module net weight
Color
Attitude
Ambient temperature
Relative humidity
Protection class
Qualifications
Standards compliance

400V					
Sinexcel AHF 005/010/015	Sinexcel AHF 025/035	Sinexcel AHF 050/060	Sinexcel AHF 075/100	Sinexcel AHF 150	Sinexcel AHF 300
System Parameter					
380 (228V~456V)					
50/60Hz (range: 45Hz~62Hz)					
Unlimited					
≥97% (Full load)					
3P3W/3P4W					
50/5~10000/5	50/5-10000/5 (15A); 150/5~30,000/5 (25~150A) module; 600/5~10000/5 (300A)				
3-Level					
Performance Indicator					
5A/10A/15A	25A/35A	50A/60A	75A/100A	150A	300A
Harmonic compensation, Reactive power compensation, Unbalance compensation					
Intelligent FFT/ Instantaneous Reactive Power/FFT					
2 <sup>nd</sup> to 61 <sup>th</sup> orders			2 <sup>nd</sup> to 50 <sup>th</sup> orders		
≥95%					
20μs			<50μs		
5ms			<5ms		
Adjustable from -1 to +1					
Average 50KHz			Average 20KHz		
96CFM	321CFM	321CFM	543CFM	825CFM	1060CFM
<68dB	<56dB			<65 dB	<75dB
Communication & Monitoring Capability					
RS485		RS485,		Ethernet port (RJ45)	
MODBUS (RTU)		MODBUS (RTU, TCP/IP)			
WIFI display,7-inchHMI(central monitor)		4.3-inch HMI (module), 7-inch HMI(central monitor), LED			
Abnormal voltage/frequency protection;Inverter short-circuit protection;Abnormal output current protection;Inverter over-loaded protection,Over-temperature protection etc.,					
Available					
Available		Available, 500 alarm records			
Mechanical Properties					
Wall-mounted/Rack-mounted		Wall-mounted/		Rack-mounted/Cabinet	
410*340*45(Rack-mounted)	400*490*150 (Rack-mounted)	440*590*190 (Rack-mounted)	500*586*190(75A) 440*599*230(100A) (Rack-mounted)	500*605*270 (Rack-mounted)	500*722*370 (Rack-mounted)
410*45*340(Wall-mounted)	440*150*470 (Wall-mounted)	440*190*610 (Wall-mounted)	500*190*560(75A) 440*232*625(100A) (Wall-mounted)	500*273*623 (Wall-mounted)	500*370*722 (Wall-mounted)
4.98kg	18kg	35kg	40kg	48kg	110kg
Silver	Black				
Environment Requirement					
≤1500m; Between 1500m to 4000m, derating 1% every additional 100m					
-10°C~40°C ( may derating if ambient temperature exceeds 45 C )					
5%		~95%, non-condensing			
IP20 (IP degree		es can be customizd)			
Related Qualifications & Standards					
CE, CCS					
IEEE519		, ER G5/4, IEC 61000			

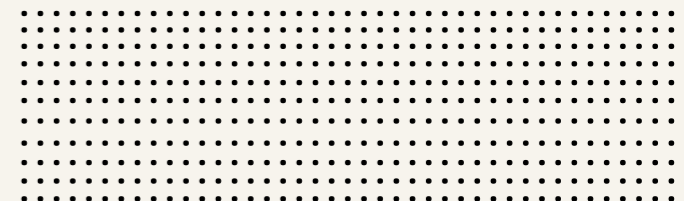

INVERTER

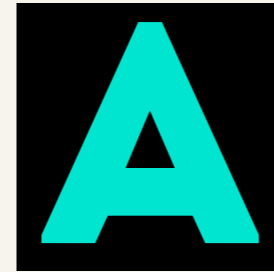
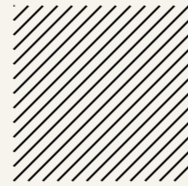

North America  
& 690V Grid voltage



Specification

Items	208V	480V	600V	690V
	Sinexcel AHF 25/35/50/60/75/100	Sinexcel AHF 25/35/50/60/75/100	Sinexcel AHF 25/35/50/60/75/100	Sinexcel AHF 25/35/50/60/75/100
<b>System Parameter</b>				
Input phase voltage range	208V(176V~264V)	480V(384V-552V)	600V(420V-690V)	690V(483V-793V)
Power grid frequency	50/60Hz (range: 45Hz~62Hz )			
Parallel operation	Unlimited			
Efficiency	≥97%			
Power grid structure	3P3W/3P4W			
CT Ratio	150/5~30,000/5			
Circuit topology	3-Level			
<b>Performance Indicator</b>				
Rated capacity	25/35/50/60/75/100A	25/35/50/60/75/100A		
Function	Harmonic compensation, Reactive power compensation, Unbalance compensation			
Control algorithm	FFT/ Intelligent FFT/ Instantaneous Reactive Power			
Filtering range	2 <sup>nd</sup> to 50 <sup>th</sup> orders			
Filtering performance	>95%			
Reaction time	<50μs			
Overall response time	<5ms			
Target power factor	Adjustable from -1 to +1			
Switching frequency	Average 20KHz			
Cooling air requirement	761CFM	For 25/35/50A 725CFM; For 60/75/100A 761CFM		
Noise level	<65dB			
<b>Communication &amp; Monitoring Capability</b>				
Communication ports	RS485, Ethernet port (RJ45)			
Communications protocols	MODBUS (RTU, TCP/IP)			
Module display interface	7-inch LCD touched screen(LED(rack-mounted)); 4.3-inch LCD touched screen(wall-mounted)			
Protection functions	Abnormal voltage/frequency protection; Inverter short-circuit protection; Abnormal output current protection; Inverter over-loaded protectio; Over-tempearture protection etc.,			
Monitoring alarm	Available			
Fault alarm	Available, 500 alarm records			
<b>Machanical Properties</b>				
Mounting type	Wall-mountedd/Rack-mounted/Cabinet			
Dimensions (WxDxH)mm	For 25/35/50A 500*540*180 (Rack-mounted) 500*184*627 (Wall-mouned) For 60/75/100A 500*675*250 (Rack-mounted) 500*250*675 (Wall-mouned)			
Module net weight	70kg	40kg (25/35/50A); 70kg (60/75/100A)		
Color	Black			
<b>Environment Requirement</b>				
Altitude	≤1500m; Between 1500m to 4000m, derating 1% every additional 100m			
Ambient temperature	-20°C-40°C (may derate capacity if ambiet temperature exceeds 45°C)			
Relative humidity	5% to 95%, non-condensing			
Protection class	IP20			
<b>Related Qualifications &amp; Standards</b>				
Qualifications	CE, cULus, DNV/BV/RINA			
Standards compliance	IEEE 519, ER G5/4, IEC 61000			

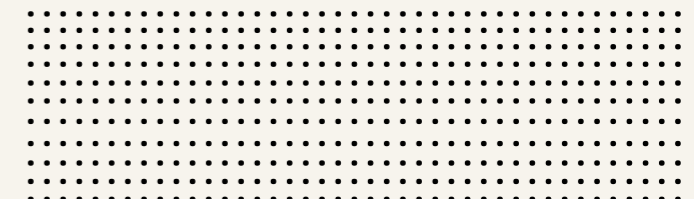



POWER  
E  
N



400V



400V



○ 25A/35A wall 440\*150\*470mm<sup>3</sup>  
 rack 400\*490\*150mm<sup>3</sup> 18kg

○ 50 /60A wall 440\*190\*610mm<sup>3</sup> rack 440\*590\*190mm<sup>3</sup> 35kg  
 75A wall 500\*190\*560mm<sup>3</sup> rack 500\*586\*190mm<sup>3</sup> 40kg  
 100A wall 440\*232\*625mm<sup>3</sup> rack 440\*599\*230mm<sup>3</sup> 40kg

# PREMIER SERIES ADVANTAGE



400V



480V  
600V  
690V

POWER  
INTELLIGENCE

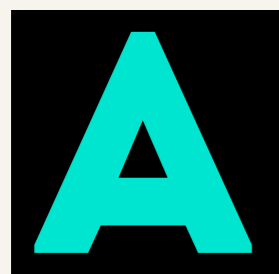

400V



5A/10A/15A wall/rack 410\*340\*45mm<sup>3</sup> 4.98kg



400V



### Flexible Engineering Cabinet

- Flexible dimension  
600\*1000\*2200mm<sup>3</sup>, 800\*1000\*2200mm<sup>3</sup>, 800\*800\*2200mm<sup>3</sup>, 1000\*1000\*2200mm<sup>3</sup>, 800\*600\*2200mm<sup>3</sup>
- Flexible Capacity  
AHF, 25A/35A/50A/60A/75A/100A/150A/300A adapt to cabinet  
SVG, 30kvar/50kvar/100kvar/200kvar adapt to cabinet  
AHF, SVG module adapt to cabinet
- Flexible incoming connection  
Top / Bottom cable entrance  
Top / Bottom MCCB position



# MONITORING

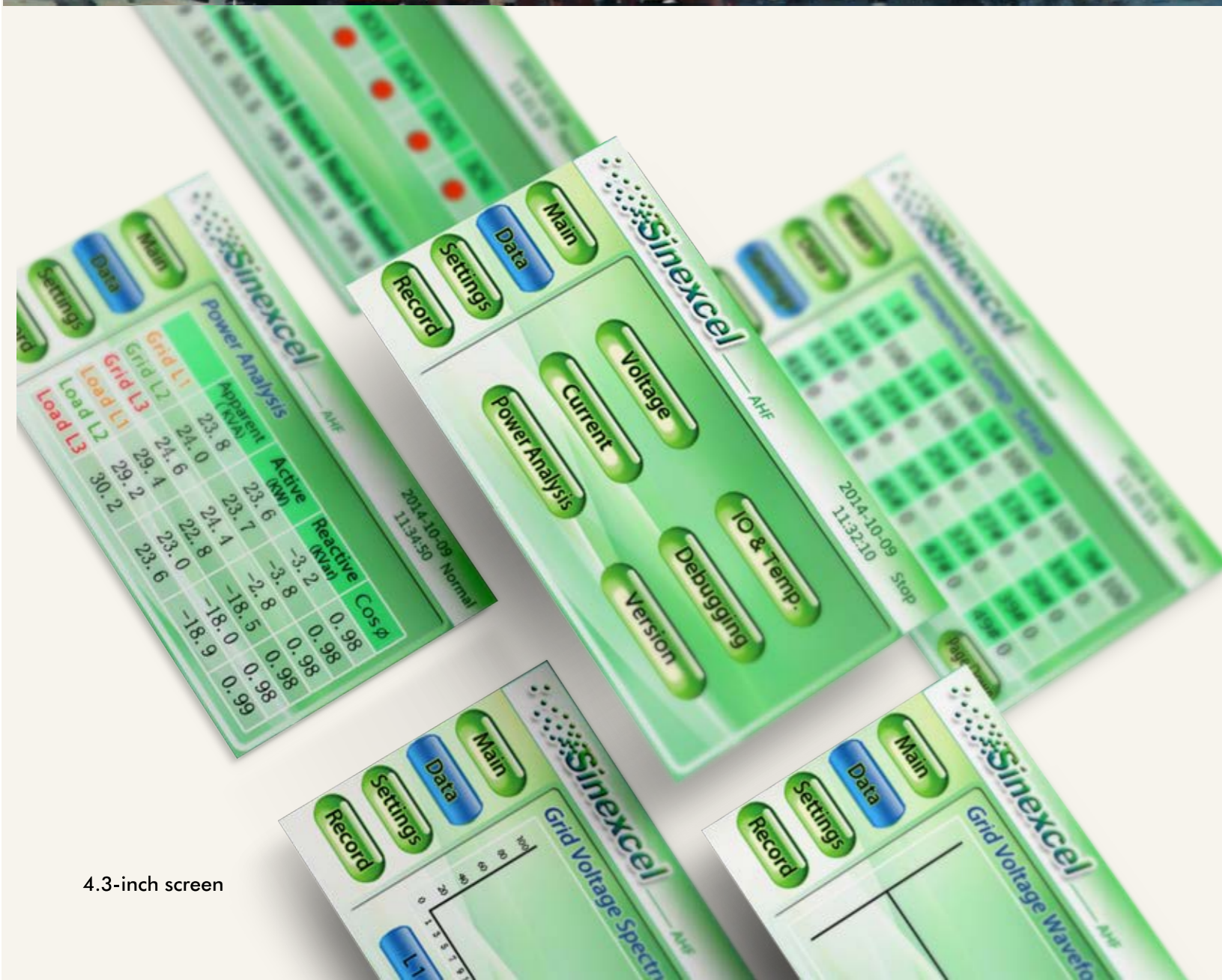

4.3-inch screen

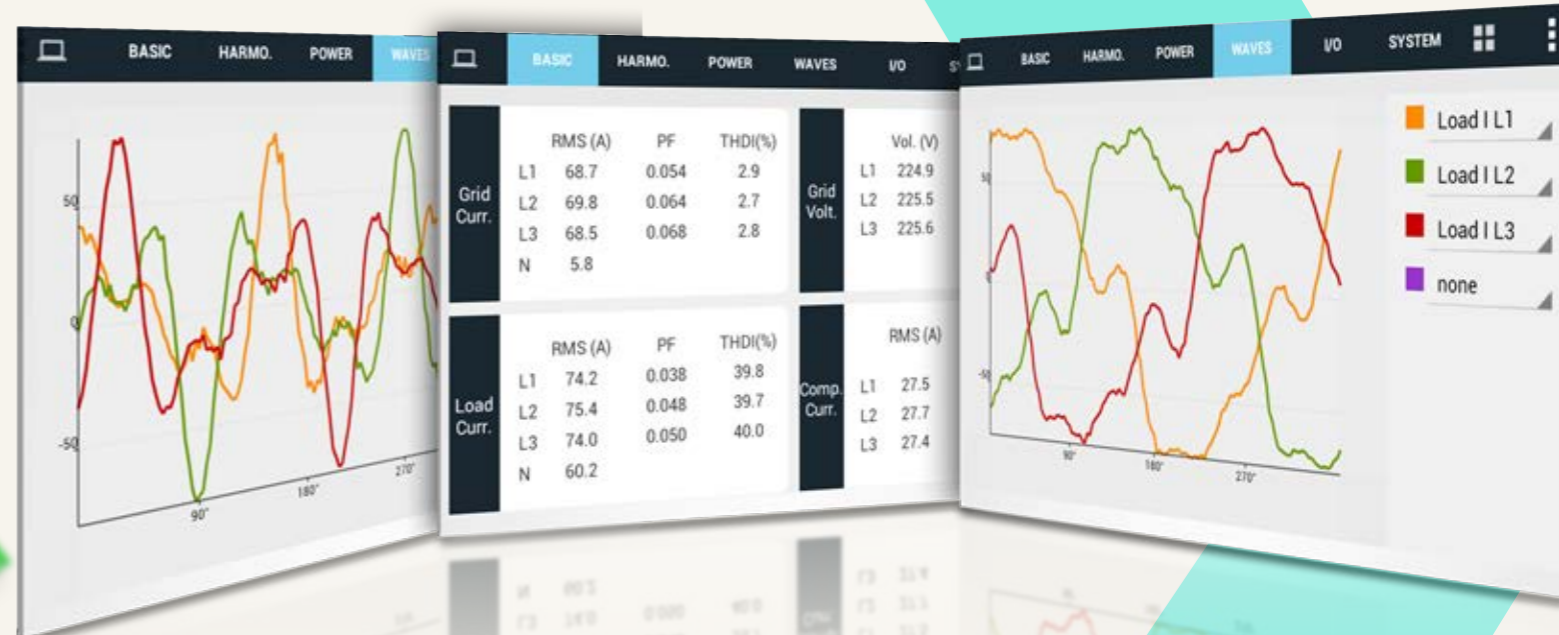

Centralized monitoring System

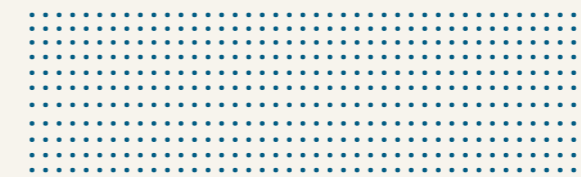



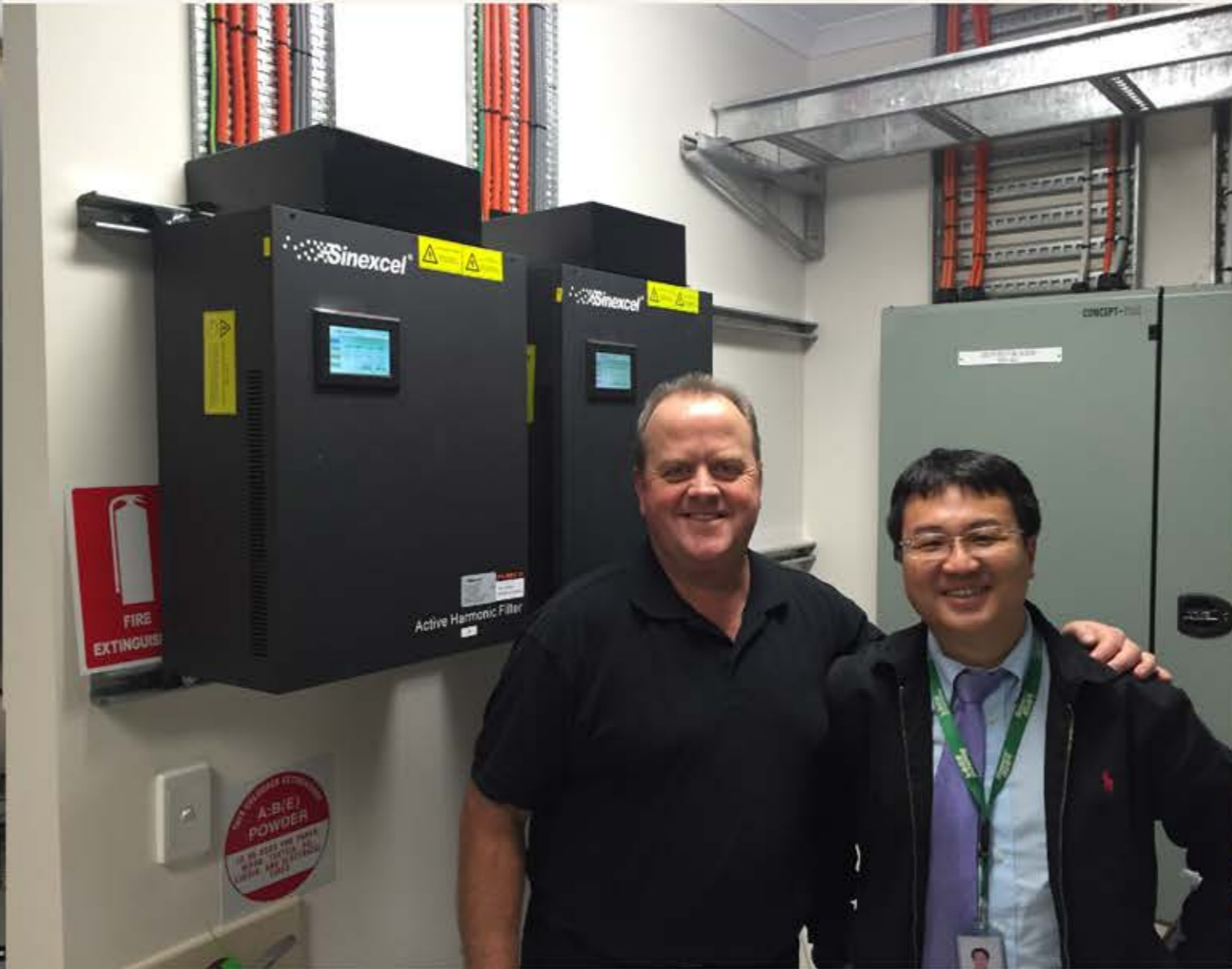



# Industrial Manufacturing

Food and beverage, plastic, paper, semiconductor, chemistry, pharmacy,  
paper, cement, oil drilling, automotive

# Infrastructure

Airport-metro and railway, tunnel, water treatment, schools/campus,  
museums, hospital, government building

More than 2.5million Ampere installation around the world

Application cover Automation Manufacturing, Infrastructure, ECO building, IDC

Application cover indoor/outdoor, high altitude hot/cold mechanical environment/dusty application,  
land/offshore severe environment

# ECO Building

Skyscraper-Commercial building, shopping mall, apartments

# IDC

Telecom, bank, internet companies





Canada, Hylife Food, AHF 1440A

# Industrial Manufacturing

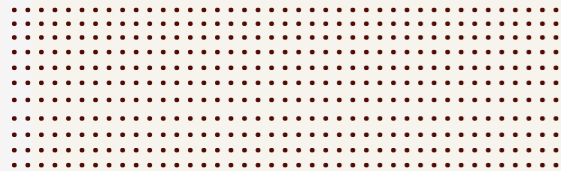

The United Kingdom, Glabina cheese, AHF 350A



# Infrastructure

Australia, Sydney Opera house, AHF 200A



China, Beijing Tian An Men Square, AHF 440A

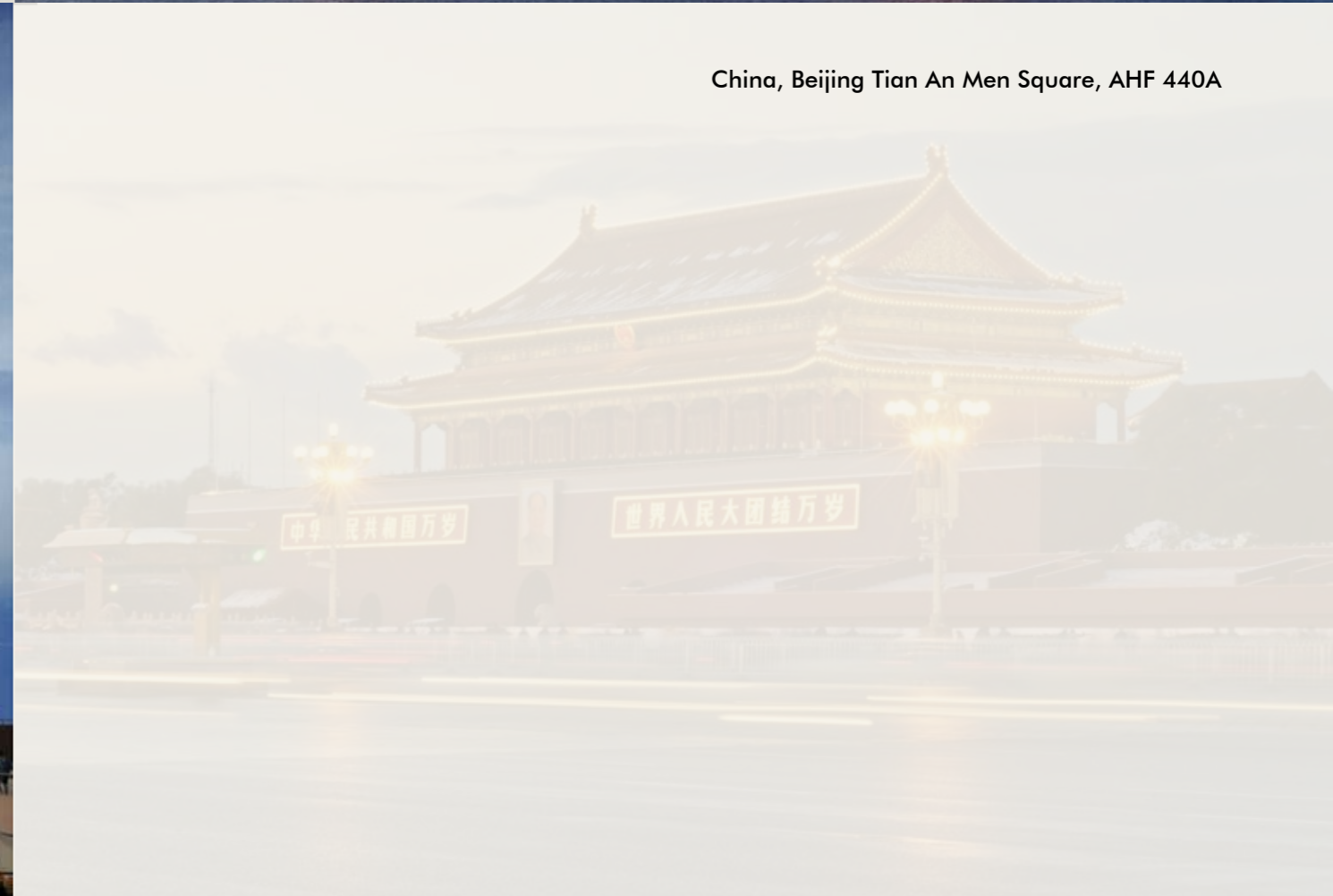





Hong Kong International Airport, AHF 6500A



Dubai International Airport, AHF 700A



Singapore Changi Airport, AHF 1950A



Gothenburg-Land Vetter Airport, SVG 270kvar



# ECO building

Singapore, Microsoft Headquarter of Southeast Asia, AHF 1800A





IDC



South Korea  
Daegu bank AHF 150A/SVG 400kvar



HongKong(China)  
China Unicom Data Centre, AHF 4425A

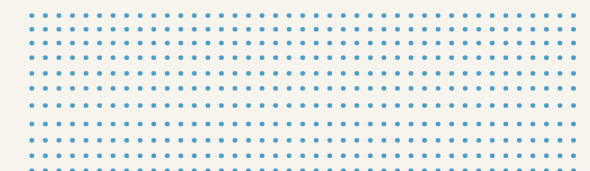





## GLOBAL APPLICATION

Sinexcel AHF application covers Asia, Oceania, Europe, Africa, North America, South America.